

**TD 434**

**TD 484**

**TD 534**

CHASSIS  
MANICO  
COMANDI  
DOTAZIONE VITERIE

DECK  
HANDLE  
CONTROLS  
SCREWS OUTFITS

CHÂSSIS  
MANCHERON  
COMMANDES  
DOTATION VISSERIE

GEHÄUSE  
HOLM  
BETÄTIGUNGEN  
SCRAUBENSATZ

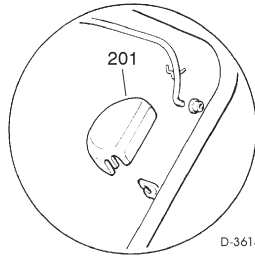

D-3615/E

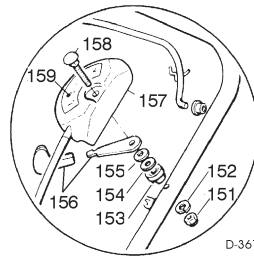

D-3615/D

SPARE PARTS CATALOGUE

ERSATZTEILKATALOG

GB

D

CATALOGO DELLE PARTI  
DI RICAMBIO

CATALOGUE DES PIÈCES  
DE RECHANGE

I

F

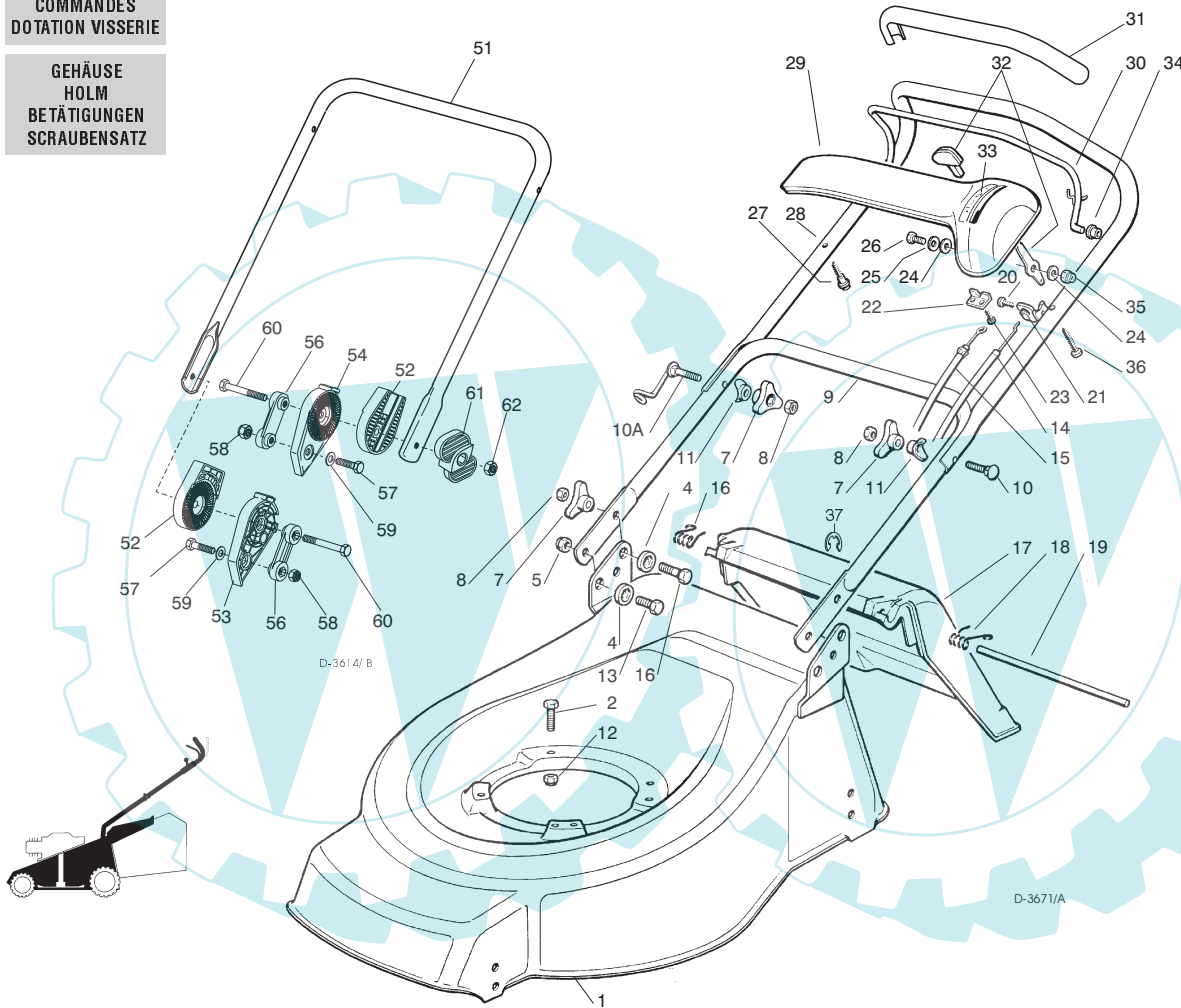

D-3614/B

D-3671/A

T-3671/A

Pos. Nr.	Codice Code Kodex	Q.tà Q.ty-Q.tè Menge	Descrizione	Description	Description	Beschreibung
1		1	CHASSIS	DECK	CHÂSSIS	GEHÄUSE
—	81001338/1	1	ROSSO TD 434	RED TD 434	OUGE TD 434	ROTES TD 434
—	81001348/1	1	GIALLO TD 434	YELLOW TD 434	JAUNE TD 434	GELBES TD 434
—	81001370/1	1	VERDE TD 434	GREEN TD 434	VERT TD 434	GRÜNES TD 434
—	81001339/0	1	ROSSO TD 484	RED TD 484	OUGE TD 484	ROTES TD 484
—	81001350/0	1	GIALLO TDL 484	YELLOW TD 484	JAUNE TD 484	GELBES TD 484
—	81001372/0	1	VERDE TD 484	GREEN TD 484	VERT TD 484	GRÜNES TD 484
—	81001735/0	1	ROSSO TD 534	RED TD 534	ROUGE TD 534	ROTES TD 534
—	81001736/0	1	GIALLO TD 534	YELLOW TD 534	JAUNE TD 534	GELBES TD 534
—	81001737/0	1	VERDE TD 534	GREEN TD 534	VERT TD 534	GRÜNES TD 534
2			VITE	SCREW	VIS	SCHRAUBE
—	12793700/0	3/2	(M8X30)	(M8X30)	(M8X30)	(M8X30)
—	12691800/0	0/1	(M8X60)	(M8X60)	(M8X60)	(M8X60)
4	22041955/0	4	BUSSOLA	BUSH	DOUILLE	BUCHSE
5	12155000/0	2	DADO	NUT	ECROU	MUTTER
6	12793700/0	2	VITE	SCREW	VIS	SCHRAUBE
7	22399900/0	4	MANOPOLINA	KNOB	POIGNÉE	GRIFF
8	12293200/0	4	DADO	NUT	ECROU	MUTTER

Pos. Nr.	Codice Code Kodex	Q.tà Q.ty-Q.tè Menge	Descrizione	Description	Description	Beschreibung	
9	81 006512/ 0	1	PARTE INF. MANICO	LOWER HANDLE	PARTIE INF. MANCHERON	UNTERHOLM	
10	12819201/ 0	1	VITE	SCREW	VIS	SCHRAUBE	
10A	81 003801/ 0	1	MOLLA GUIDA	SPRING	RESSORT	FEDER	
11	22680006/ 1	2	RONDELLA	WASHER	RONDELLE	SCHIBE	
12	12293201/ 0	3/ 2	DADO	NUT	ECROU	MUTTER	
—	12155000/ 0	0/ 1	DADO	NUT	ECROU	MUTTER	
13	123792610/ 0	2	VITE	SCREW	VIS	SCHRAUBE	
14	81 007160/ 0	1	CAVO ACCELERATORE	THROTTLE CABLE	CABLE ACCELERATEUR	BESCHLEUNIGER KABEL	
15	81000633/ 0	1	CAVO FRENO MOTORE	THREAD MOTOR BRAKE	CABLE FREIN MOTEUR	MOTORBREMSEKABEL	
—	81000623/ 1	1	TD 434 (QUANTUM XM)	TD 434 (QUANTUM XM)	TD 434 (QUANTUM XM)	TD 434 (QUANTUM XM)	
—	81000631/ 0	1	TD 434-484 (TECUMSEH)	TD 434-484 (TECUMSEH)	TD 434-484 (TECUMSEH)	TD 434-484 (TECUMSEH)	
—	81000625/ 0	1	TD 484 (QUANTUM XM-ES 40)	TD 484 (QUANTUM XM-ES 40)	TD 484 (QUANTUM XM-ES 40)	TD 484 (QUANTUM XM-ES 40)	
—	81000641/ 0	1	TD 484 (SPRINT 375/ QUATTRO)	TD 484 (SPRINT 375/ QUATTRO)	TD 484 (SPRINT 375/ QUATTRO)	TD 484 (SPRINT 375/ QUATTRO)	
—	81000641/ 0	1	TD 484 (HONDA GCV 135/ 160)	TD 484 (HONDA GCV 135/ 160)	TD 484 (HONDA GCV 135/ 160)	TD 484 (HONDA GCV 135/ 160)	
—	81000642/ 0	1	TD 534 (QUANTUM XM-ES 40)	TD 534 (QUANTUM XM-ES 40)	TD 534 (QUANTUM XM-ES 40)	TD 534 (QUANTUM XM-ES 40)	
—	81000643/ 0	1	TD 534 (SPRINT 375/ QUATTRO)	TD 534 (SPRINT 375/ QUATTRO)	TD 534 (SPRINT 375/ QUATTRO)	TD 534 (SPRINT 375/ QUATTRO)	
—	81000644/ 0	1	TD 534 (TECUMSEH)	TD 534 (TECUMSEH)	TD 534 (TECUMSEH)	TD 534 (TECUMSEH)	
—	81000640/ 0	1	TD 534 (HONDA GCV 135/ 160)	TD 534 (HONDA GCV 135/ 160)	TD 534 (HONDA GCV 135/ 160)	TD 534 (HONDA GCV 135/ 160)	
16	22450410/ 1	1	MOLLA DX	RIGHT SPRING	RESSORT DROITE	RECHTE FEDER	
17	22600046/ 1	1	PARASASSI	STONE-GUARD	PARE-PIERRES	PRALLBLECH	
18	22450420/ 1	1	MOLLA SX	LEFT SPRING	RESSORT GAUCHE	LINKE FEDER	
19	22517906/ 1	1	PERNO	PIN	PIVOT	BOLZEN	
20	12728518/ 0	1	VITE	SCREW	VIS	SCHRAUBE	
21	22806612/ 0	1	SUPPORTO	SUPPORT	SUPPORT	HALTER	
22	22981467/ 0	1	PIASTRINA	PLAQUE	PLAQUETTE	PLATTE	
23	12735105/ 0	2	VITE	SCREW	VIS	SCHRAUBE	
24	12523040/ 0	2	RONDELLA	WASHER	RONDELLE	SCHIBE	
25	12530060/ 0	1	RONDELLA ELASTICA	SPRING WASHER	RONDELLE ELASTIQUE	ELASTISCHE SCHEIBE	
26	12791500/ 0	1	VITE	SCREW	VIS	SCHRAUBE	
27	22943006/ 0	1	VITE	SCREW	VIS	SCHRAUBE	
28	81 007018/ 0	1	PARTE SUP. MANICO	UPPER HANDLE	PARTIE SUP. MANCHERON	OBERHOLM	
29	22120154/ 0	1	CRUSCOTTO	DASH BOARD	CONSOLE	KONSOLE	
—	22120152/ 0	1	ROSSO	RED	ROUGE	ROTE	
—	22120158/ 0	1	GIALLO	YELLOW	JAUNE	GELBE	
—	22120158/ 0	1	NERO	BLACK	NOIRE	SCHWARZE	
30	81 003291/ 2	1	LEVA FRENO MOTORE	BRAKE LEVER	LEVIER FREIN MOTEUR	MOTORBREMSEHEBEL	
31	22291050/ 0	1	IMPUGNATURA MANICO	HANDGRIP	POIGNÉE	HANDGRIFF	
—	22291051/ 0	1	NERA	BLACK	NOIRE	SCHWARZER	
—	22291052/ 0	1	ROSSA	RED	ROUGE	RÖTER	
—	22291052/ 0	1	GIALLA	YELLOW	JAUNE	GELBER	
32	81 007280/ 2	1	ASS. LEVA + MANOPOLINA	LEVER + KNOB ASS. Y	ENS. LEVIER + POIGNÉE	HEBEL + GRIFF SATZ	
33	14356743/ 0	1	ETICHETTA (TECUMSEH-HONDA)	LABEL (TECUMSEH-HONDA)	ETIQUETTE (TECUMSEH-HONDA)	ETIKETTE (TECUMSEH-HONDA)	
—	14356744/ 0	1	(B&S)	(B&S)	(B&S)	(B&S)	
34	22041966/ 0	2	BOCCOLA	BUSH	DOUILLE	BUCHSE	
35	12154510/ 0	1	DADO	NUT	ECROU	MUTTER	
36	12728460/ 0	1	VITE	SCREW	VIS	SCHRAUBE	
37	12000930/ 0	1	ANELLO ELASTICO	SNAP RING	ANNEAU RESSORT	SPRENGRING	
—	81 008614/ 1	1	DOTAZIONE VITERIA	SCREWS OUTFIT	DOTATION VISSERIE	SCHRAUBEN SATZ	
—	81 008609/ 0	1	DOTAZIONE CRUSCOTTO	DASH-BOARD OUTFIT	DOTATION CONSOLE	KONSOLE SATZ	
			<b>VARIANTE REGOLAZIONE MANICO</b>	<b>HANDLE ADJUSTMENT VARIANT</b>	<b>VARIANTE REGLAGE POIGNEE</b>	<b>GRIFFEINSTELLVARIANTE</b>	
T-3615/ B	51	81 006510/ 0	1	PARTE INFR. MANICO	LOWER HANDLE	PARTIE INF. MANCHERON	UNTERHOLM
52	22785081/ 0	2	SUPPORTO ESTERNO	EXTERNAL SUPPORT	SUPPORT EXTERNE	AUßERE HALTERUNG	
53	22785082/ 0	1	SUPPORTO INTERNO DX	R. INTERNAL SUPPORT	SUPPORT INTERNE DROIT	INNERE HALTERUNG RECHTS	
54	22785083/ 1	1	SUPPORTO INTERNO SX	L. INTERNAL SUPPORT	SUPPORT INTERNE GAUCHE	INNERE HALTERUNG LINKS	
56	22551575/ 0	2	PIASTRINA INTERNA	INSIDE PLAQUE	PLAQUETTE INTERNE	INNERE PLATTE	
57	12793701/ 0	2	VITE	SCREW	VIS	SCHRAUBE	
58	12155000/ 0	2	DADO	NUT	ECROU	MUTTER	
59	12521350/ 0	2	RONDELLA	WASHER	RONDELLE	SCHIBE	
60	12691810/ 0	2	VITE	SCREW	VIS	SCHRAUBE	
61	22399803/ 0	2	MANOPOLINA	KNOB	POIGNÉE	GRIFF	
62	12293202/ 0	2	DADO	NUT	ECROU	MUTTER	
—	81 008623/ 0	1	DOTAZ. VITERIA	SCREWS OUTFIT	DOTATION VISSERIE	SCHRAUBEN SATZ	
			<b>VARIANTE ACCELERATORE</b>	<b>THROTTLE VARIANTS</b>	<b>VARIANTES COMMANDE D'ACCELERATION</b>	<b>ÄNDERUNGEN AUF GASHEBEL</b>	
T-3616/ D	151	12291000/ 0	1	DADO	NUT	ECROU	MUTTER
152	12581500/ 0	1	GROWER	GROWER	GROWER	FEDERRING	
153	22171005/ 0	1	DISTANZIALE	SPACER	ENTRETOISE	DISTANZRING	
154	12521360/ 0	1	RONDELLA	WASHER	RONDELLE	SCHIBE	
155	12508100/ 0	1	RONDELLA ELASTICA	SPRING WASHER	RONDELLE ELASTIQUE	ELASTISCHE SCHEIBE	
156	81 007279/ 1	1	ASS. LEVA + MANOPOLINA	LEVER + KNOB ASS. Y	ENS. LEVIER + POIGNÉE	HEBEL + GRIFF SATZ	
157	81 007080/ 0	1	ASSIEME ACCELERATORE	TROTTLE UNIT ASS. Y	ENS. ACCELERATEUR	BESCHLEUNIGER SATZ	
158	12815000/ 0	1	VITE	SCREW	VIS	SCHRAUBE	
159	14356702/ 0	1	ETICHETTA (TECUMSEH-HONDA)	LABEL (TECUMSEH-HONDA)	ETIQUETTE (TECUMSEH-HONDA)	ETIKETTE (TECUMSEH-HONDA)	
—	14356703/ 0	1	(B&S)	(B&S)	(B&S)	(B&S)	

Pos. Nr.	Codice Code Kodex	Q.tà Q.ty-Q.tè Menge	Descrizione	Description	Description	Beschreibung
----------	-------------------	----------------------	-------------	-------------	-------------	--------------

T-3615/E

VARIANTE REGIME FISSO	FIXED SPEED VARIANTS	VARIANTES POUR MODELE À REGIME FIXE	ÄNDERUNGEN FÜR MODELLE MIT FIXIERTER DREHZAHL
-----------------------	----------------------	-------------------------------------	---

201	22601000/0	PROTEZIONE	PROTECTION	PROTECTION	SCHUTZ
-----	------------	------------	------------	------------	--------

**RUOTE E REGOLAZIONE**

**WHEELS AND HEIGHT ADJUSTING**

**ROUES ET REGLAGE HAUTER DE COUPE**

**RÄDER UND SCHNITTHÖHEVERSTELLUNG**

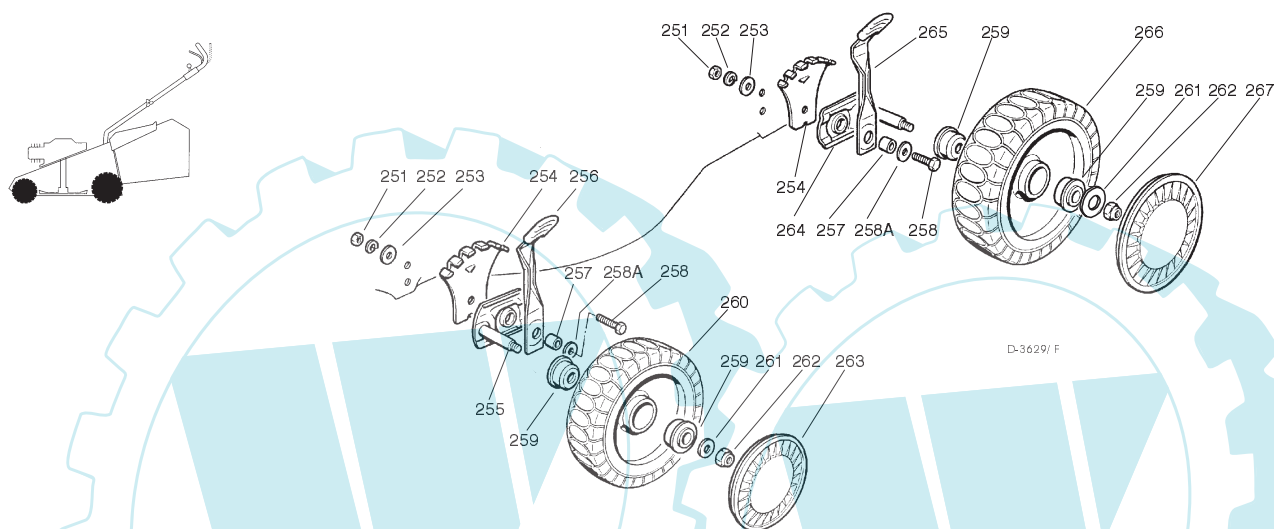

T-3629/F

251	12293200/0	4	DADO	NUT	ECROU	MUTTER
252	12583500/0	4	GROWER	GROWER	GROWER	FEDERRING
253	12523070/0	4	RONDELLA	WASHER	RONDELLE	SCHEIBE
254	22735547/0	4	SETTORE REGOLAZIONE	ADJUSTMENT SECTOR	SECTEUR REGLAGE	VERSTELLUNGSEKTOR
255	81005082/0	2	SUPPORTO RUOTA	WHEEL SUPPORT	SUPPORT ROUE	RADHALTER
256	81003285/0	2	LEVA REGOLAZIONE	ADJUSTMENT LEVER	LEVIER REGLAGE	VERSTELLUNGHEBEL
257	22171001/0	4	DISTANZIALE	SPACER	ENTRETOISE	DISTANZRING
258	12793701/0	4	VITE	SCREW	VIS	SCHRAUDE
258A	12521350/0	4	RONDELLA	WASHER	RONDELLE	SCHEIBE
259	22034508/0	8	BOCCOLA	BUSH	DOUILLE	BUCHSE
260	81007317/0	2	RUOTA SCOLPITA Ø 170	KNOBBLY WHEEL Ø 170	ROUE SCULPTEE Ø 170	RAD M. STOLLENPR. Ø 170
261	12523060/0	4	RONDELLA	WASHER	RONDELLE	SCHEIBE
262	12155000/0	4	DADO	NUT	ECROU	MUTTER
263			COPRIMOZZO	HUB CAP	COUVRE-MOYEU	RADKAPPE
—	22110282/0	2	BIANCO	WHITE	BLANC	WEIßE
—	22110288/0	2	GIALLO	YELLOW	JAUNE	GELB
—	22110290/0	2	ROSSO	RED	ROUGE	ROTE
264	81005084/0	2	SUPPORTO RUOTA	WHEEL SUPPORT	SUPPORT ROUE	RADHALTER
265	81003286/0	2	LEVA REGOLAZIONE	ADJUSTMENT LEVER	LEVIER REGLAGE	VERSTELLUNGHEBEL
266	81007318/1	2	RUOTA SCOLPITA Ø 210	KNOBBLY WHEEL Ø 210	ROUE SCULPTEE Ø 210	RAD M. STOLLENPR. Ø 210
267			COPRIMOZZO	HUB CAP	COUVRE-MOYEU	RADKAPPE
—	22110281/0	2	BIANCO	WHITE	BLANC	WEIßE
—	22110287/0	2	GIALLO	YELLOW	JAUNE	GELB
—	22110289/0	2	ROSSO	RED	ROUGE	ROTE

Pos. Nr.	Codice Code Kodex	Q.tà Q.ty-Q.tè Menge	Descrizione	Description	Description	Beschreibung
----------	-------------------	----------------------	-------------	-------------	-------------	--------------

- GRUPPO COLTELLO
- BLADE ASS.Y
- GROUPE LAME
- MESSERSATZ

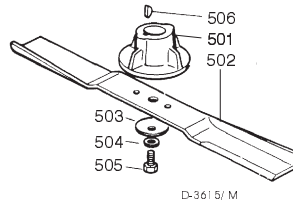
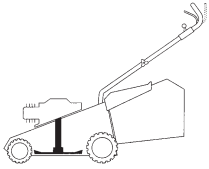

D-361 5/ M

T-3623/ M

501	22463012/ 1	1	MOZZO	HUB	MOYEU	HALTER
502			COLTELLO	BLADE	LAME	MESSER
—	81004341/ 2	1	STANDARD 41 cm.	STANDARD 41 cm.	STANDARD 41 cm.	STANDARD 41 cm.
—	81004396/ 0	1	ALETTATO 41 cm.	WINGED 41 cm.	AILETTÉE 41 cm.	FLÜGEL 41 cm
—	81004346/ 2	1	STANDARD 46 cm.	STANDARD 46 cm.	STANDARD 46 cm.	STANDARD 46 cm.
—	81004397/ 0	1	ALETTATO 46 cm.	WINGED 46 cm.	AILETTÉE 46 cm.	FLÜGEL 46 cm
—	81004381/ 0	1	STANDARD 51 cm.	STANDARD 51 cm.	STANDARD 51 cm.	STANDARD 51 cm.
—	81004398/ 0	1	ALETTATO 51 cm.	WINGED 51 cm.	AILETTÉE 51 cm.	FLÜGEL 51 cm
503	22160400/ 0	1	DISCO ELASTICO	ELASTIC WASHER	RONDELLE ELASTIQUE	ELASTISCHE SCHEIBE
504	12523080/ 0	1	RONDELLA	WASHER	RONDELLE	SCHEIBE
505	12735698/ 0	1	VITE	SCREW	VIS	SCHRAUBE
506	12139100/ 0	1	LINGUETTA	FEATHER	CLAVETTE	KEIL

- SACCO RACCOGLIERBA
- GRASS-CATCHER
- BAC DE RAMASSAGE
- GRASFANGKORB

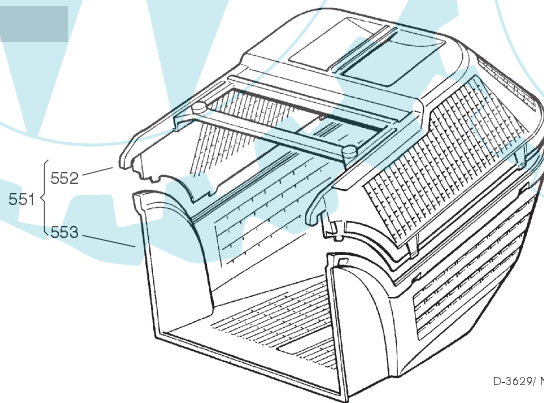
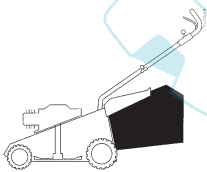

D-3629/ N

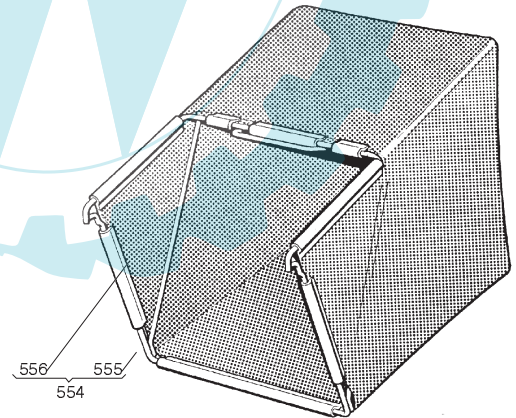

T-3629/ N

551	94004000/ 1	1	SACCO COMPLETO	COMPLETE GRASS-BOX	SAC COMPLET	KOMPLETTER KORB
552	22486073/ 0	1	PARTE SUP. SACCO	UPPER GRASS BOX	PARTIE SUP. SAC	OBERKORB
553	22486074/ 0	1	PARTE INF. SACCO	LOWER GRASS BOX	PARTIE INF. SAC	UNTERKORB
554	94005000/ 0	1	ASS. SACCO IN TELA	CANVASS GRASSCATCHER	ENSEMBLE SAC EN TOILE	KOMPLETTER SACK
555	81006418/ 0	1	TELAIO	CHASSIS	CHÂSSIS	RAHMEN
556	81002105/ 2	1	TELA SACCO	FABRIC BOX	TOILE POUR SAC	TUCK FÜR SACK